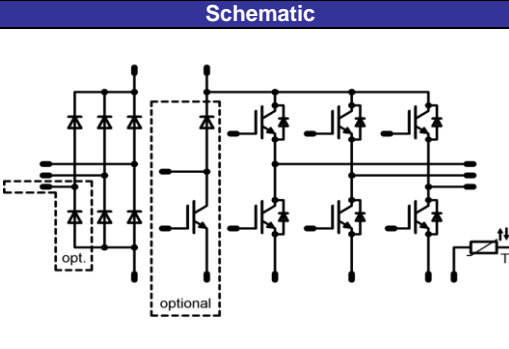

flowPIM 0	600V/20A
<div style="border: 1px solid black; padding: 5px; margin-bottom: 10px;"> <p style="text-align: center; background-color: #000080; color: white; margin: 0;"><b>Features</b></p> <ul style="list-style-type: none"> <li>Vincotech clip-in housing</li> <li>Trench Fieldstop IGBT's for low saturation losses</li> <li>Optional w/o BRC</li> </ul> </div> <div style="border: 1px solid black; padding: 5px; margin-bottom: 10px;"> <p style="text-align: center; background-color: #000080; color: white; margin: 0;"><b>Target Applications</b></p> <ul style="list-style-type: none"> <li>Industrial drives</li> <li>Embedded drives</li> </ul> </div> <div style="border: 1px solid black; padding: 5px;"> <p style="text-align: center; background-color: #000080; color: white; margin: 0;"><b>Types</b></p> <ul style="list-style-type: none"> <li>V23990-P545-A28-PM</li> <li>V23990-P545-A29-PM</li> <li>V23990-P545-C28-PM w/o BRC</li> <li>V23990-P545-C29-PM w/o BRC</li> </ul> </div>	<div style="border: 1px solid black; padding: 5px; margin-bottom: 10px;"> <p style="text-align: center; background-color: #000080; color: white; margin: 0;"><b>flowPIM 0 housing</b></p>  <p style="text-align: center; margin: 0;">12mm housing      17mm housing</p> </div> <div style="border: 1px solid black; padding: 5px;"> <p style="text-align: center; background-color: #000080; color: white; margin: 0;"><b>Schematic</b></p>  <p style="text-align: center; margin: 0;">opt.      optional</p> </div>

## Maximum Ratings

 $T_j=25^{\circ}\text{C}$ , unless otherwise specified

Parameter	Symbol	Condition	Value	Unit
<b>Input Rectifier Diode</b>				
Repetitive peak reverse voltage	$V_{RRM}$		1600	V
DC forward current	$I_{FAV}$	$T_j=T_{jmax}$ $T_h=80^{\circ}\text{C}$ $T_c=80^{\circ}\text{C}$	28 37	A
Surge forward current	$I_{FSM}$	$t_p=10\text{ms}$ 50 Hz half sine wave $T_j=25^{\circ}\text{C}$	200	A
I2t-value	$I^2t$		200	$\text{A}^2\text{s}$
Power dissipation per Diode	$P_{tot}$	$T_j=T_{jmax}$ $T_h=80^{\circ}\text{C}$ $T_c=80^{\circ}\text{C}$	33 50	W
Maximum Junction Temperature	$T_{jmax}$		150	$^{\circ}\text{C}$
<b>Inverter Transistor</b>				
Collector-emitter break down voltage	$V_{CE}$		600	V
DC collector current	$I_C$	$T_j=T_{jmax}$ $T_h=80^{\circ}\text{C}$ $T_c=80^{\circ}\text{C}$	23 30	A
Repetitive peak collector current	$I_{Cpulse}$	$t_p$ limited by $T_{jmax}$	60	A
Turn off safe operating area		$V_{CE} \leq 1200\text{V}$ , $T_j \leq T_{jmax}$	60	A
Power dissipation per IGBT	$P_{tot}$	$T_j=T_{jmax}$ $T_h=80^{\circ}\text{C}$ $T_c=80^{\circ}\text{C}$	47 72	W
Gate-emitter peak voltage	$V_{GE}$		$\pm 20$	V
Short circuit ratings	$t_{SC}$ $V_{CC}$	$T_j \leq 150^{\circ}\text{C}$ $V_{GE}=15\text{V}$	6 360	$\mu\text{s}$ V
Maximum Junction Temperature	$T_{jmax}$		175	$^{\circ}\text{C}$

## Maximum Ratings

 $T_j=25^{\circ}\text{C}$ , unless otherwise specified

Parameter	Symbol	Condition	Value	Unit
-----------	--------	-----------	-------	------

### Inverter Diode

Peak Repetitive Reverse Voltage	$V_{RRM}$		600	V
DC forward current	$I_F$	$T_j=T_{jmax}$ $T_h=80^{\circ}\text{C}$ $T_c=80^{\circ}\text{C}$	27 35	A
Repetitive peak forward current	$I_{FRM}$	$t_p$ limited by $T_{jmax}$	40	A
Power dissipation per Diode	$P_{tot}$	$T_j=T_{jmax}$ $T_h=80^{\circ}\text{C}$ $T_c=80^{\circ}\text{C}$	36 55	W
Maximum Junction Temperature	$T_{jmax}$		175	$^{\circ}\text{C}$

### Brake Transistor

Collector-emitter break down voltage	$V_{CE}$		600	V
DC collector current	$I_C$	$T_j=T_{jmax}$ $T_h=80^{\circ}\text{C}$ $T_c=80^{\circ}\text{C}$	17 22	A
Repetitive peak collector current	$I_{Cpuls}$	$t_p$ limited by $T_{jmax}$	45	A
Turn off safe operating area		$V_{CE} \leq 1200\text{V}$ , $T_j \leq T_{jmax}$	45	A
Power dissipation per IGBT	$P_{tot}$	$T_j=T_{jmax}$ $T_h=80^{\circ}\text{C}$ $T_c=80^{\circ}\text{C}$	37 56	W
Gate-emitter peak voltage	$V_{GE}$		$\pm 20$	V
Short circuit ratings	$t_{SC}$ $V_{CC}$	$T_j \leq 150^{\circ}\text{C}$ $V_{GE} = 15\text{V}$	6 360	$\mu\text{s}$ V
Maximum Junction Temperature	$T_{jmax}$		175	$^{\circ}\text{C}$

### Brake Diode

Peak Repetitive Reverse Voltage	$V_{RRM}$		600	V
DC forward current	$I_F$	$T_j=T_{jmax}$ $T_h=80^{\circ}\text{C}$ $T_c=80^{\circ}\text{C}$	16 21	A
Repetitive peak forward current	$I_{FRM}$	$t_p$ limited by $T_{jmax}$	30	A
Power dissipation per Diode	$P_{tot}$	$T_j=T_{jmax}$ $T_h=80^{\circ}\text{C}$ $T_c=80^{\circ}\text{C}$	28 43	W
Maximum Junction Temperature	$T_{jmax}$		175	$^{\circ}\text{C}$

### Thermal Properties

Storage temperature	$T_{stg}$		-40...+125	$^{\circ}\text{C}$
Operation temperature under switching condition	$T_{op}$		-40...+( $T_{jmax} - 25$ )	$^{\circ}\text{C}$

### Insulation Properties

Insulation voltage	$V_{is}$	$t=2\text{s}$ DC voltage	4000	V
Creepage distance			min 12,7	mm
Clearance			min 12,7	mm
Comparative tracking index	CTI		>200	

**Characteristic Values**

Parameter	Symbol	Conditions					Value			Unit
		$V_{GE}[V]$ or $V_{GS}[V]$	$V_r[V]$ or $V_{CE}[V]$ or $V_{DS}[V]$	$I_c[A]$ or $I_F[A]$ or $I_b[A]$	$T_j$	Min	Typ	Max		
<b>Input Rectifier Diode</b>										
Forward voltage	$V_F$				30	$T_j=25^\circ\text{C}$ $T_j=125^\circ\text{C}$	0,8	1,26 1,24	1,45	V
Threshold voltage (for power loss calc. only)	$V_{to}$				30	$T_j=25^\circ\text{C}$ $T_j=125^\circ\text{C}$		0,92 0,82		V
Slope resistance (for power loss calc. only)	$r_t$				30	$T_j=25^\circ\text{C}$ $T_j=125^\circ\text{C}$		11 14		m $\Omega$
Reverse current	$I_r$			1500		$T_j=25^\circ\text{C}$ $T_j=145^\circ\text{C}$			1,1	mA
Thermal resistance chip to heatsink per chip	$R_{thJH}$	Thermal grease thickness $\leq 50\mu\text{m}$ $\lambda = 1 \text{ W/mK}$						2,10		K/W

**Inverter Transistor**

Gate emitter threshold voltage	$V_{GE(th)}$	$V_{CE}=V_{GE}$			0,00029	$T_j=25^\circ\text{C}$ $T_j=150^\circ\text{C}$	5	5,8	6,5	V	
Collector-emitter saturation voltage	$V_{CE(sat)}$		15		20	$T_j=25^\circ\text{C}$ $T_j=150^\circ\text{C}$	1	1,55 1,75	2,2	V	
Collector-emitter cut-off current incl. Diode	$I_{CES}$		0	600		$T_j=25^\circ\text{C}$ $T_j=150^\circ\text{C}$			0,0011	mA	
Gate-emitter leakage current	$I_{GES}$		20	0		$T_j=25^\circ\text{C}$ $T_j=150^\circ\text{C}$			300	nA	
Integrated Gate resistor	$R_{gint}$							none		$\Omega$	
Turn-on delay time	$t_{d(on)}$	$R_{goff}=8 \Omega$ $R_{gon}=16 \Omega$	$\pm 15$	300	20	$T_j=25^\circ\text{C}$		15		ns	
Rise time	$t_r$					$T_j=150^\circ\text{C}$		14			
Turn-off delay time	$t_{d(off)}$					$T_j=25^\circ\text{C}$		12			
Fall time	$t_f$					$T_j=150^\circ\text{C}$		16			
Turn-on energy loss per pulse	$E_{on}$					$T_j=25^\circ\text{C}$		198			
Turn-off energy loss per pulse	$E_{off}$	$T_j=150^\circ\text{C}$		212							
Input capacitance	$C_{ies}$	$f=1\text{MHz}$	0	25		$T_j=25^\circ\text{C}$		1100		pF	
Output capacitance	$C_{oss}$						$T_j=25^\circ\text{C}$		71		
Reverse transfer capacitance	$C_{rss}$								32		
Gate charge	$Q_{Gate}$		$\pm 15$	480	20	$T_j=25^\circ\text{C}$		120		nC	
Thermal resistance chip to heatsink per chip	$R_{thJH}$	Thermal grease thickness $\leq 50\mu\text{m}$ $\lambda = 1 \text{ W/mK}$						2,01		K/W	

**Inverter Diode**

Diode forward voltage	$V_F$				20	$T_j=25^\circ\text{C}$ $T_j=150^\circ\text{C}$	1,25	1,81 1,76	1,95	V
Peak reverse recovery current	$I_{RRM}$	$R_{gon}=16 \Omega$	$\pm 15$	300	20	$T_j=25^\circ\text{C}$		19		A
Reverse recovery time	$t_{rr}$					$T_j=150^\circ\text{C}$		21		
Reverse recovered charge	$Q_{rr}$					$T_j=25^\circ\text{C}$		33		
Peak rate of fall of recovery current	$di(rec)_{max}/dt$					$T_j=150^\circ\text{C}$		192		
Reverse recovered energy	$E_{rec}$					$T_j=25^\circ\text{C}$		0,45		
		$T_j=150^\circ\text{C}$		1,35						
Thermal resistance chip to heatsink per chip	$R_{thJH}$	Thermal grease thickness $\leq 50\mu\text{m}$ $\lambda = 1 \text{ W/mK}$						2,63		K/W

**Characteristic Values**

Parameter	Symbol	Conditions					Value			Unit
		$V_{GE}[V]$ or $V_{GS}[V]$	$V_r[V]$ or $V_{CE}[V]$ or $V_{DS}[V]$	$I_c[A]$ or $I_F[A]$ or $I_D[A]$	$T_j$	Min	Typ	Max		
<b>Brake Transistor</b>										
Gate emitter threshold voltage	$V_{GE(th)}$	$V_{CE}=V_{GE}$			0,00021	$T_j=25^\circ C$ $T_j=150^\circ C$	5	5,8	6,5	V
Collector-emitter saturation voltage	$V_{CE(sat)}$		15		15	$T_j=25^\circ C$ $T_j=150^\circ C$	1,1	1,64 1,86	1,9	V
Collector-emitter cut-off incl diode	$I_{CES}$		0	600		$T_j=25^\circ C$ $T_j=150^\circ C$			0,00085	mA
Gate-emitter leakage current	$I_{GES}$		20	0		$T_j=25^\circ C$ $T_j=150^\circ C$			300	nA
Integrated Gate resistor	$R_{gint}$							none		$\Omega$
Turn-on delay time	$t_{d(on)}$	Rgoff=8 $\Omega$ Rgon=16 $\Omega$	$\pm 15$	300	15	$T_j=25^\circ C$		15		ns
Rise time	$t_r$					$T_j=150^\circ C$		14		
Turn-off delay time	$t_{d(off)}$					$T_j=25^\circ C$		11		
Fall time	$t_f$					$T_j=150^\circ C$		14		
Turn-on energy loss per pulse	$E_{on}$					$T_j=25^\circ C$		128		
Turn-off energy loss per pulse	$E_{off}$	$T_j=150^\circ C$		145						
Input capacitance	$C_{ies}$							860		pF
Output capacitance	$C_{oss}$	f=1MHz	0	25		$T_j=25^\circ C$		55		
Reverse transfer capacitance	$C_{rss}$							24		
Gate charge	$Q_{Gate}$		$\pm 15$	480	15	$T_j=25^\circ C$		87		nC
Thermal resistance chip to heatsink per chip	$R_{thJH}$	Thermal grease thickness $\leq 50\mu m$ $\lambda = 1 W/mK$						2,55		K/W
<b>Brake Diode</b>										
Diode forward voltage	$V_F$				15	$T_j=25^\circ C$ $T_j=150^\circ C$	1,25	1,86 1,75	1,95	V
Reverse leakage current	$I_r$	Rgon=16 $\Omega$		600		$T_j=25^\circ C$ $T_j=150^\circ C$			27	$\mu A$
Peak reverse recovery current	$I_{RRM}$	Rgon=16 $\Omega$	$\pm 15$	300	15	$T_j=25^\circ C$		14		A
Reverse recovery time	$t_{rr}$					$T_j=150^\circ C$		15		
Reverse recovered charge	$Q_{rr}$					$T_j=25^\circ C$		128		
Peak rate of fall of recovery current	$di(rec)max/dt$					$T_j=150^\circ C$		201		
Reverse recovery energy	$E_{rec}$					$T_j=25^\circ C$		0,52		
		$T_j=150^\circ C$		0,52						
Thermal resistance chip to heatsink per chip	$R_{thJH}$	Thermal grease thickness $\leq 50\mu m$ $\lambda = 1 W/mK$						3,35		K/W
<b>Thermistor</b>										
Rated resistance	R					$T_j=25^\circ C$		22000		$\Omega$
Deviation of R100	$\Delta R/R$	R100=1486 $\Omega$				$T_c=100^\circ C$	-5		5	%
Power dissipation	P					$T_c=100^\circ C$		210		mW
Power dissipation constant						$T_j=25^\circ C$		3,5		mW/K
B-value	$B_{(25/50)}$	Tol. $\pm 3\%$				$T_j=25^\circ C$				K
B-value	$B_{(25/100)}$	Tol. $\pm 3\%$				$T_j=25^\circ C$		4000		K
Vincotech NTC Reference						$T_j=25^\circ C$			A	

## Output Inverter

**Figure 1** Output inverter IGBT

**Typical output characteristics**

$I_C = f(V_{CE})$

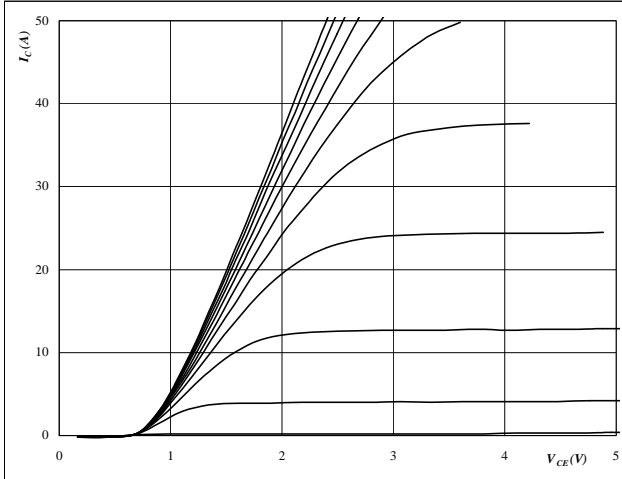

**At**  
 $t_p = 250 \mu s$   
 $T_J = 25 \text{ }^\circ C$   
 $V_{GE}$  from 7 V to 17 V in steps of 1 V

**Figure 2** Output inverter IGBT

**Typical output characteristics**

$I_C = f(V_{CE})$

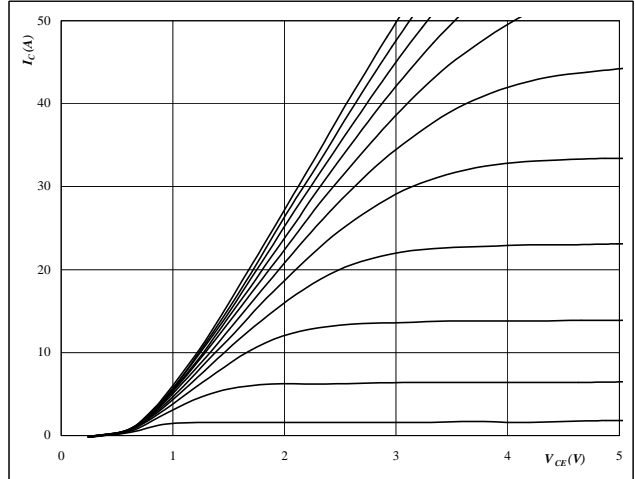

**At**  
 $t_p = 250 \mu s$   
 $T_J = 125 \text{ }^\circ C$   
 $V_{GE}$  from 7 V to 17 V in steps of 1 V

**Figure 3** Output inverter IGBT

**Typical transfer characteristics**

$I_C = f(V_{GE})$

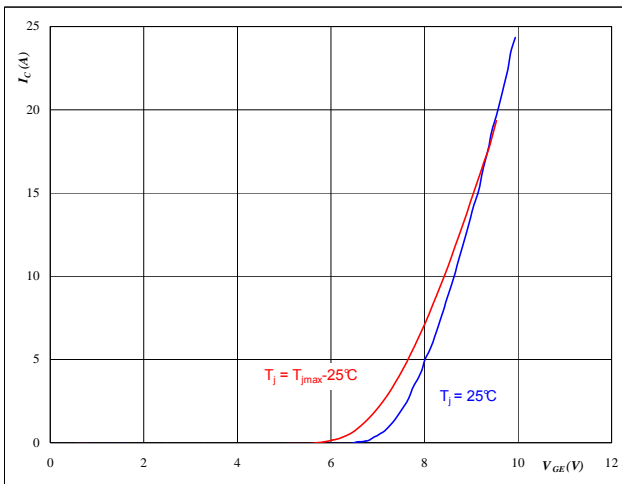

**At**  
 $t_p = 250 \mu s$   
 $V_{CE} = 10 \text{ V}$

**Figure 4** Output inverter FWD

**Typical diode forward current as a function of forward voltage**

$I_F = f(V_F)$

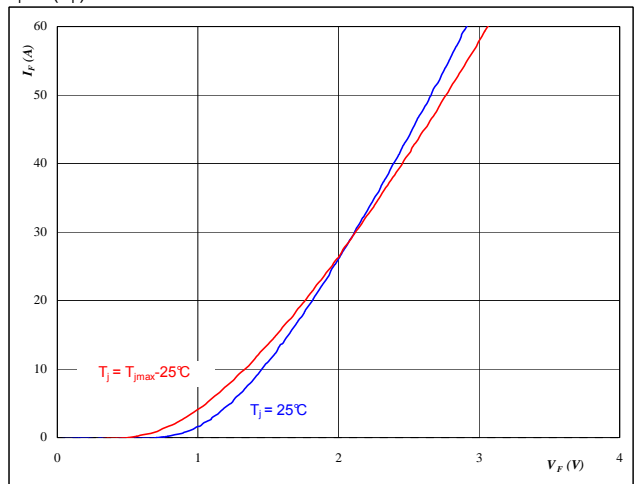

**At**  
 $t_p = 250 \mu s$

## Output Inverter

**Figure 5** Output inverter IGBT

Typical switching energy losses  
as a function of collector current

$E = f(I_C)$

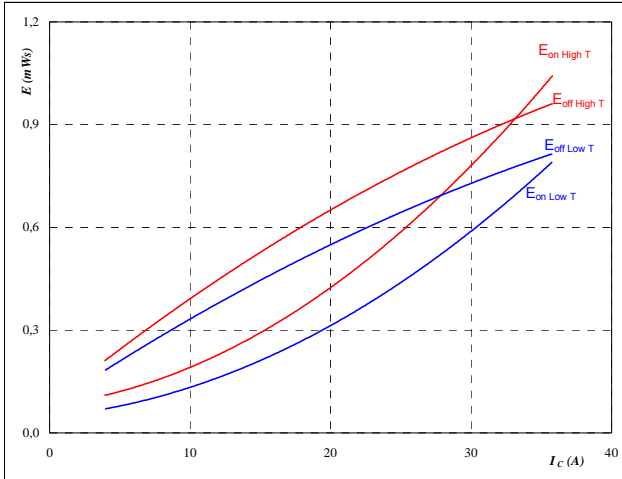

With an inductive load at

$T_J = 25/125 \text{ } ^\circ\text{C}$   
 $V_{CE} = 300 \text{ V}$   
 $V_{GE} = 15 \text{ V}$   
 $R_{gon} = 16 \text{ } \Omega$   
 $R_{goff} = 8 \text{ } \Omega$

**Figure 6** Output inverter IGBT

Typical switching energy losses  
as a function of gate resistor

$E = f(R_G)$

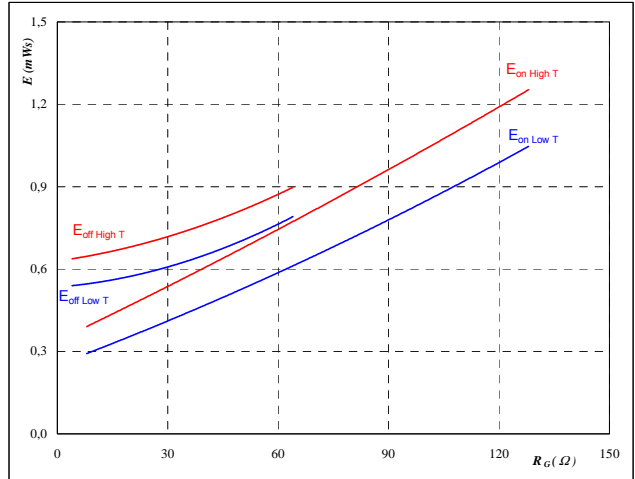

With an inductive load at

$T_J = 25/125 \text{ } ^\circ\text{C}$   
 $V_{CE} = 300 \text{ V}$   
 $V_{GE} = 15 \text{ V}$   
 $I_C = 20 \text{ A}$

**Figure 7** Output inverter FWD

Typical reverse recovery energy loss  
as a function of collector current

$E_{rec} = f(I_C)$

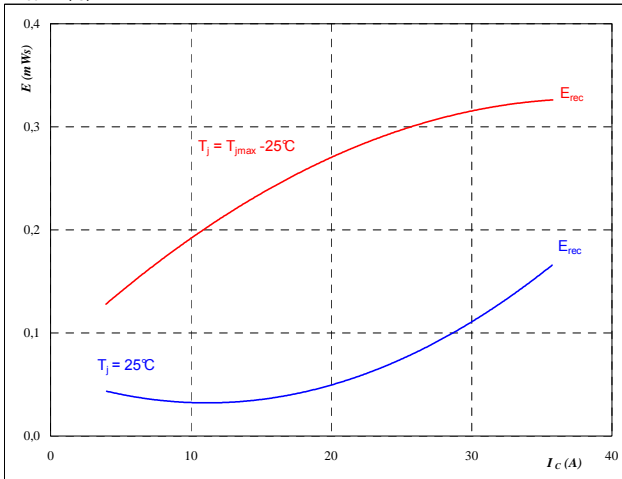

With an inductive load at

$T_J = 25/125 \text{ } ^\circ\text{C}$   
 $V_{CE} = 300 \text{ V}$   
 $V_{GE} = 15 \text{ V}$   
 $R_{gon} = 16 \text{ } \Omega$

**Figure 8** Output inverter FWD

Typical reverse recovery energy loss  
as a function of gate resistor

$E_{rec} = f(R_G)$

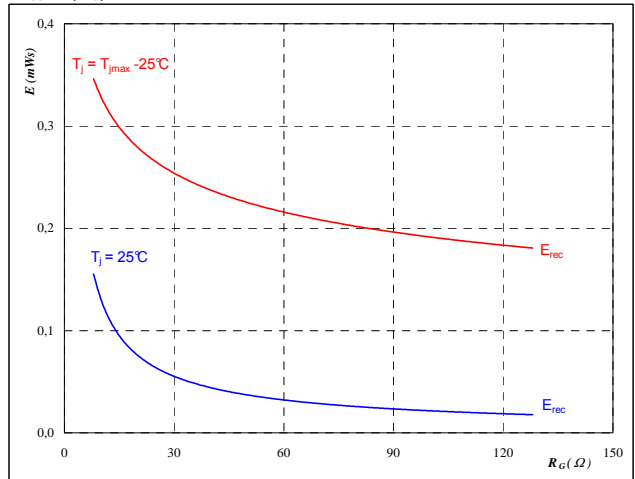

With an inductive load at

$T_J = 25/125 \text{ } ^\circ\text{C}$   
 $V_{CE} = 300 \text{ V}$   
 $V_{GE} = 15 \text{ V}$   
 $I_C = 20 \text{ A}$

## Output Inverter

Figure 9 Output inverter IGBT

Typical switching times as a function of collector current

$$t = f(I_C)$$

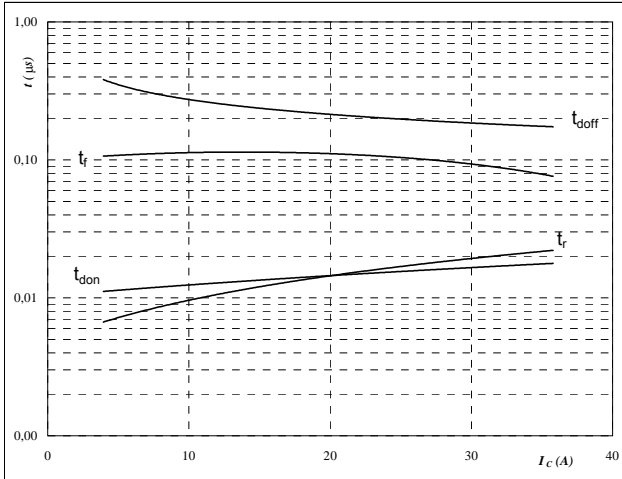

With an inductive load at

$T_J =$	125	°C
$V_{CE} =$	300	V
$V_{GE} =$	15	V
$R_{gon} =$	16	Ω
$R_{goff} =$	8	Ω

Figure 10 Output inverter IGBT

Typical switching times as a function of gate resistor

$$t = f(R_G)$$

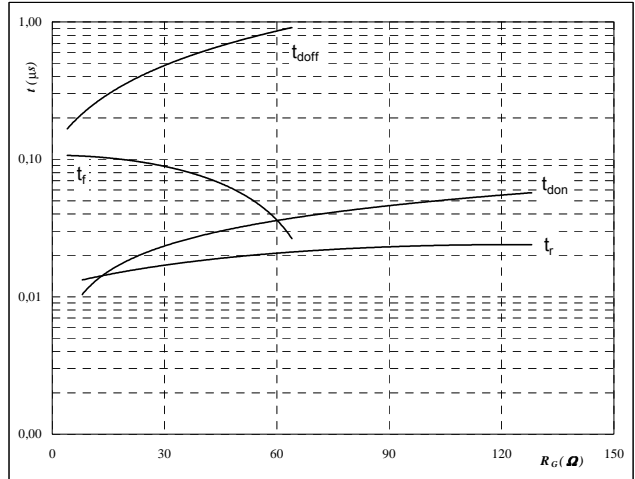

With an inductive load at

$T_J =$	125	°C
$V_{CE} =$	300	V
$V_{GE} =$	15	V
$I_C =$	20	A

Figure 11 Output inverter FWD

Typical reverse recovery time as a function of collector current

$$t_{rr} = f(I_C)$$

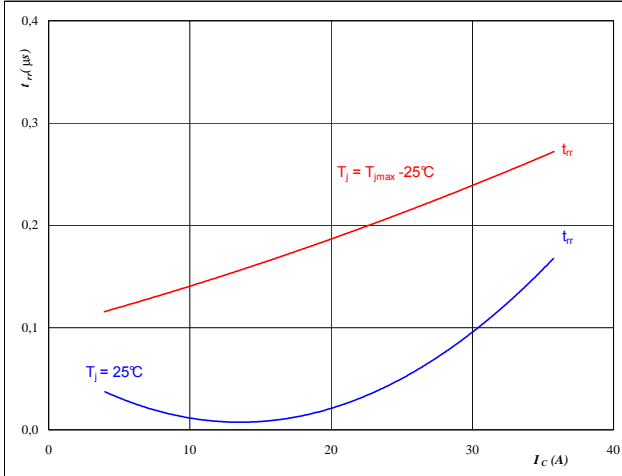

At

$T_J =$	25/125	°C
$V_{CE} =$	300	V
$V_{GE} =$	15	V
$R_{gon} =$	16	Ω

Figure 12 Output inverter FWD

Typical reverse recovery time as a function of IGBT turn on gate resistor

$$t_{rr} = f(R_{gon})$$

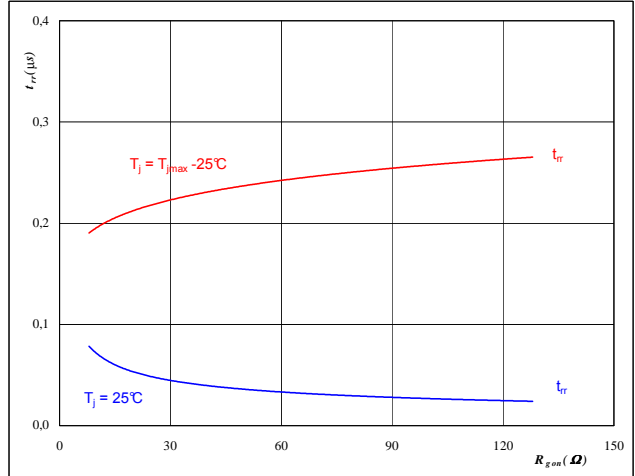

At

$T_J =$	25/125	°C
$V_R =$	300	V
$I_F =$	20	A
$V_{GE} =$	15	V

## Output Inverter

Figure 13 Output inverter FWD

Typical reverse recovery charge as a function of collector current

$$Q_{rr} = f(I_C)$$

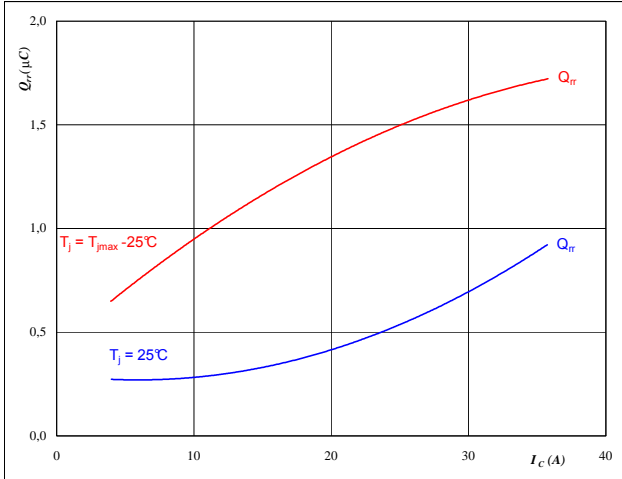

At  
 $T_j = 25/125$  °C  
 $V_{CE} = 300$  V  
 $V_{GE} = 15$  V  
 $R_{gon} = 16$  Ω

Figure 14 Output inverter FWD

Typical reverse recovery charge as a function of IGBT turn on gate resistor

$$Q_{rr} = f(R_{gon})$$

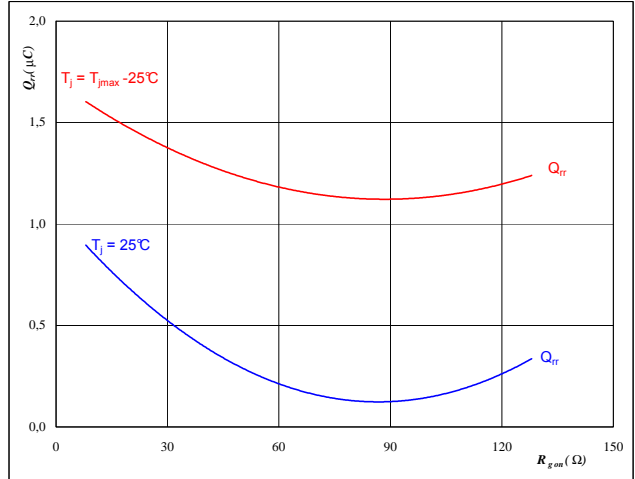

At  
 $T_j = 25/125$  °C  
 $V_R = 300$  V  
 $I_F = 20$  A  
 $V_{GE} = 15$  V

Figure 15 Output inverter FWD

Typical reverse recovery current as a function of collector current

$$I_{RRM} = f(I_C)$$

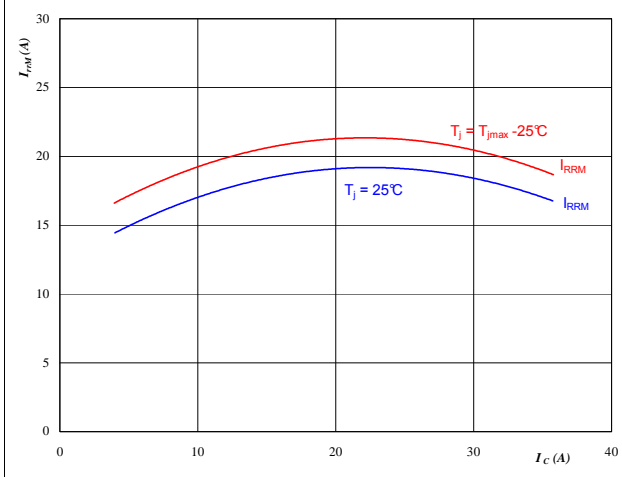

At  
 $T_j = 25/125$  °C  
 $V_{CE} = 300$  V  
 $V_{GE} = 15$  V  
 $R_{gon} = 16$  Ω

Figure 16 Output inverter FWD

Typical reverse recovery current as a function of IGBT turn on gate resistor

$$I_{RRM} = f(R_{gon})$$

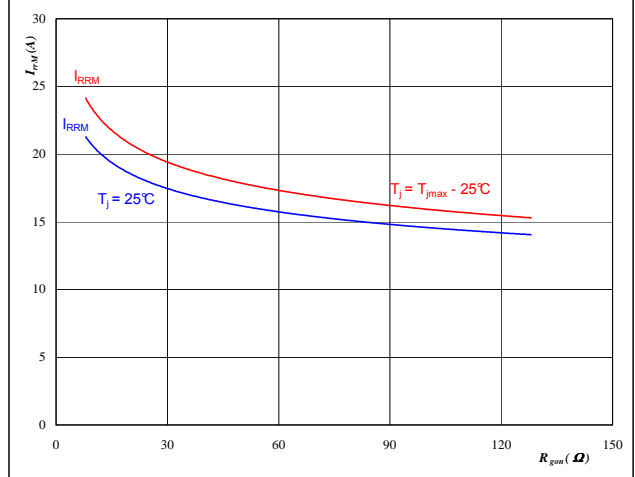

At  
 $T_j = 25/125$  °C  
 $V_R = 300$  V  
 $I_F = 20$  A  
 $V_{GE} = 15$  V



## Output Inverter

Figure 17 Output inverter FWD

Typical rate of fall of forward and reverse recovery current as a function of collector current

$$dI_f/dt, dI_{rec}/dt = f(I_C)$$

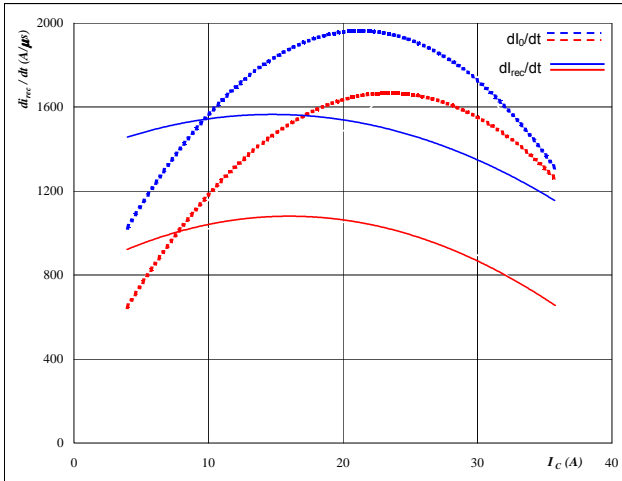

At  
 $T_j = 25/125 \text{ } ^\circ\text{C}$   
 $V_{CE} = 300 \text{ V}$   
 $V_{GE} = 15 \text{ V}$   
 $R_{gon} = 16 \text{ } \Omega$

Figure 18 Output inverter FWD

Typical rate of fall of forward and reverse recovery current as a function of IGBT turn on gate resistor

$$dI_f/dt, dI_{rec}/dt = f(R_{gon})$$

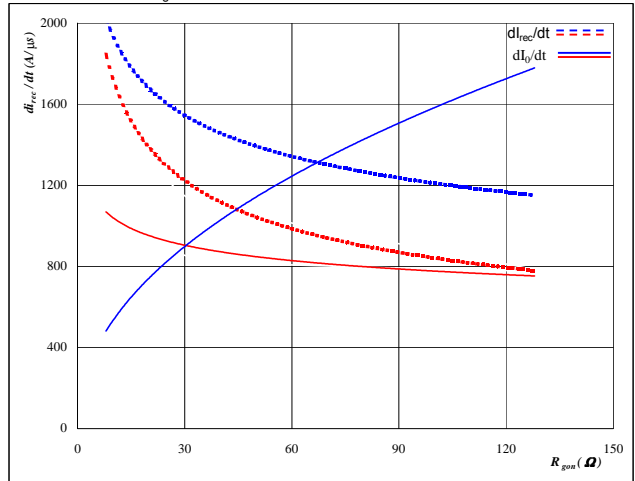

At  
 $T_j = 25/125 \text{ } ^\circ\text{C}$   
 $V_R = 300 \text{ V}$   
 $I_F = 20 \text{ A}$   
 $V_{GE} = 15 \text{ V}$

Figure 19 Output inverter IGBT

IGBT transient thermal impedance as a function of pulse width

$$Z_{thJH} = f(t_p)$$

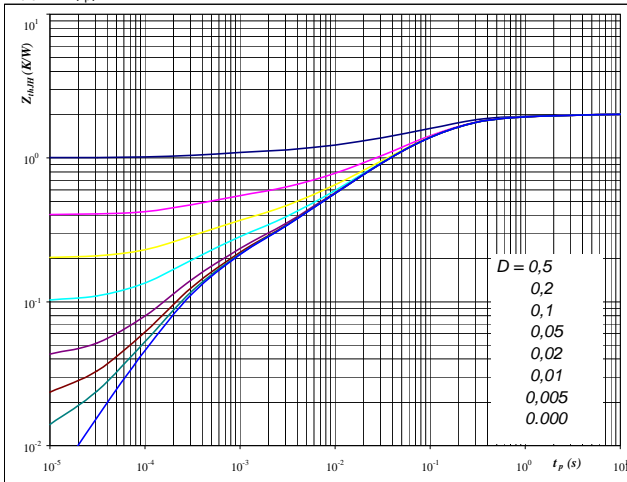

At  
 $D = t_p / T$   
 $R_{thJH} = 2,01 \text{ K/W}$

IGBT thermal model values

Thermal grease		Phase change interface	
R (C/W)	Tau (s)	R (C/W)	Tau (s)
0,09	2,9E+00	0,07	2,4E+00
0,31	3,5E-01	0,25	2,9E-01
0,94	8,8E-02	0,76	7,1E-02
0,38	1,6E-02	0,31	1,3E-02
0,14	2,9E-03	0,11	2,4E-03
0,14	3,3E-04	0,12	2,7E-04

Figure 20 Output inverter FWD

FWD transient thermal impedance as a function of pulse width

$$Z_{thJH} = f(t_p)$$

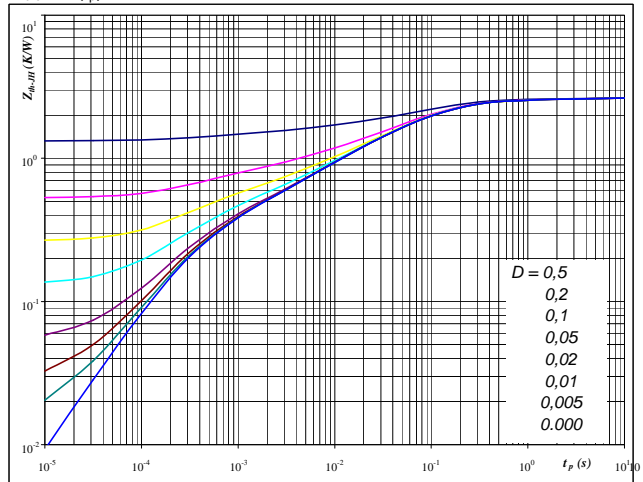

At  
 $D = t_p / T$   
 $R_{thJH} = 2,63 \text{ K/W}$

FWD thermal model values

Thermal grease		Phase change interface	
R (C/W)	Tau (s)	R (C/W)	Tau (s)
0,10	3,6E+00	0,08	2,9E+00
0,31	3,6E-01	0,25	3,0E-01
1,14	8,0E-02	0,92	6,5E-02
0,52	1,7E-02	0,42	1,4E-02
0,31	2,9E-03	0,25	2,3E-03
0,26	3,3E-04	0,21	2,7E-04

## Output Inverter

**Figure 21** Output inverter IGBT

**Power dissipation as a function of heatsink temperature**

$$P_{tot} = f(T_h)$$

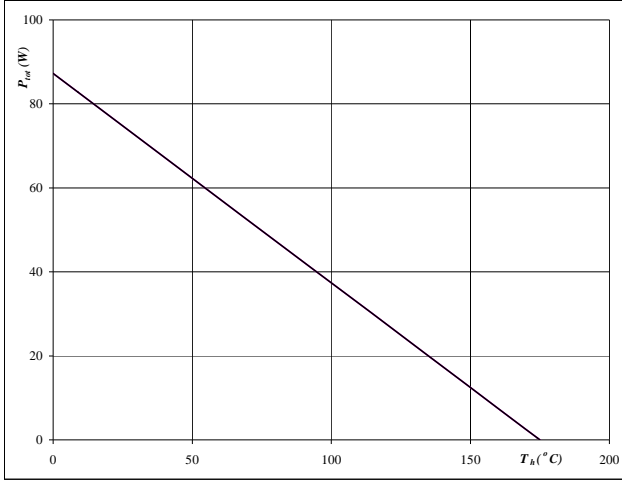

**At**  
 $T_j = 175$  °C

**Figure 22** Output inverter IGBT

**Collector current as a function of heatsink temperature**

$$I_C = f(T_h)$$

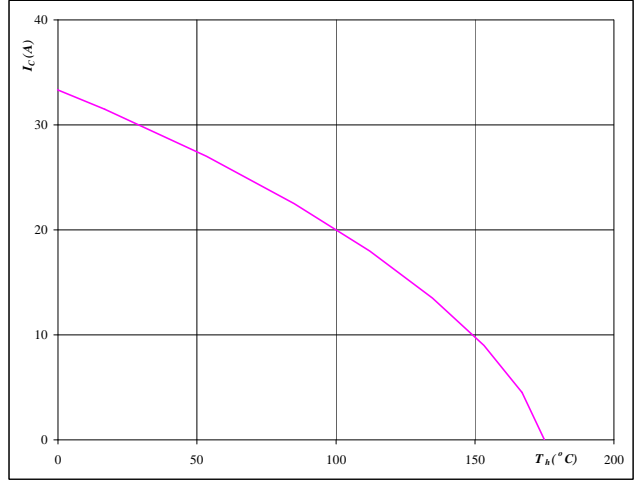

**At**  
 $T_j = 175$  °C  
 $V_{GE} = 15$  V

**Figure 23** Output inverter FWD

**Power dissipation as a function of heatsink temperature**

$$P_{tot} = f(T_h)$$

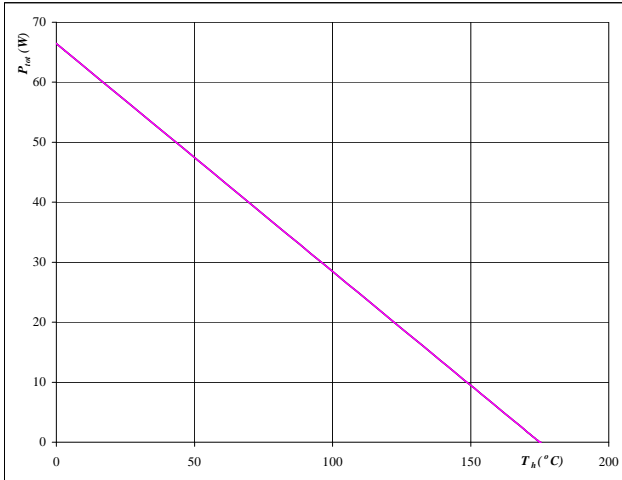

**At**  
 $T_j = 175$  °C

**Figure 24** Output inverter FWD

**Forward current as a function of heatsink temperature**

$$I_F = f(T_h)$$

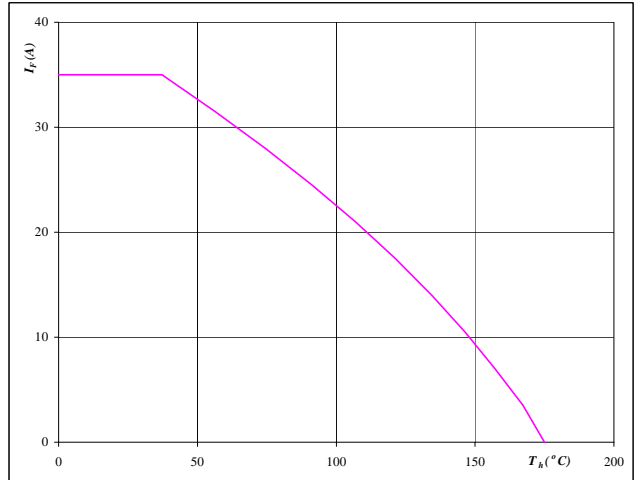

**At**  
 $T_j = 175$  °C

## Output Inverter

Figure 25 Output inverter IGBT

Safe operating area as a function of collector-emitter voltage  
 $I_C = f(V_{CE})$

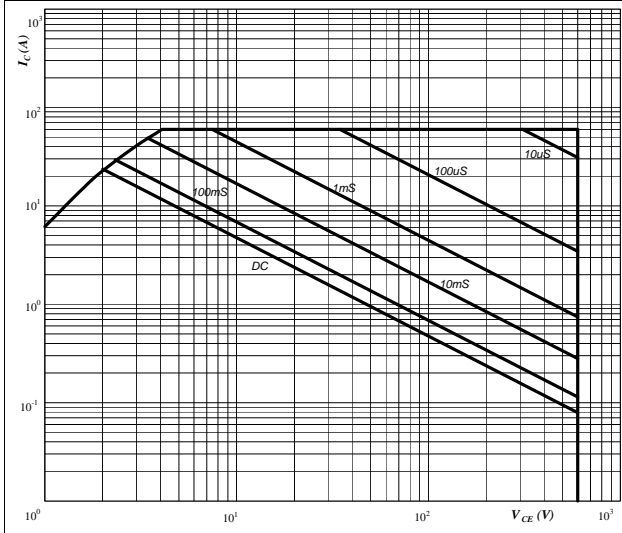

At  
 D = single pulse  
 $T_n = 80 \text{ } ^\circ\text{C}$   
 $V_{GE} = 15 \text{ V}$   
 $T_j = T_{jmax} \text{ } ^\circ\text{C}$

Figure 26 Output inverter IGBT

Gate voltage vs Gate charge

$V_{GE} = f(Q_{GE})$

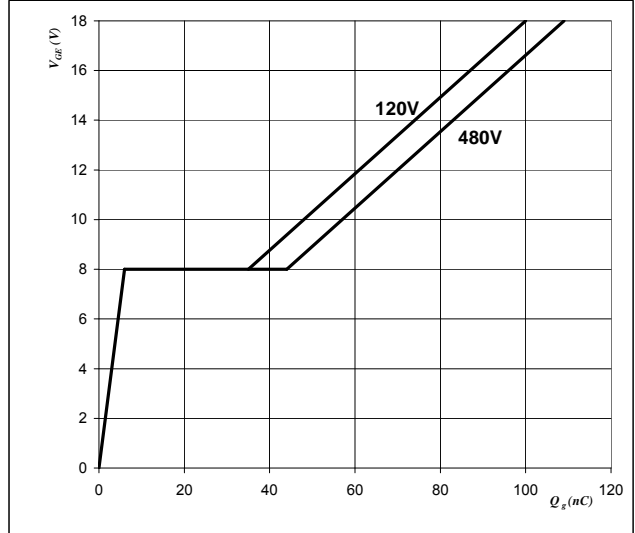

At  
 $I_C = 20 \text{ A}$

Figure 27 Output inverter IGBT

Short circuit withstand time as a function of gate-emitter voltage  
 $t_{sc} = f(V_{GE})$

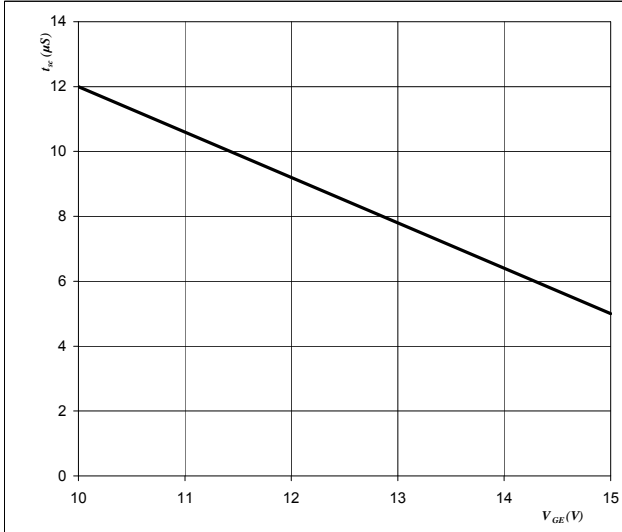

At  
 $V_{CE} = 600 \text{ V}$   
 $T_j \leq 175 \text{ } ^\circ\text{C}$

Figure 28 Output inverter IGBT

Typical short circuit collector current as a function of gate-emitter voltage  
 $V_{GE} = f(Q_{GE})$

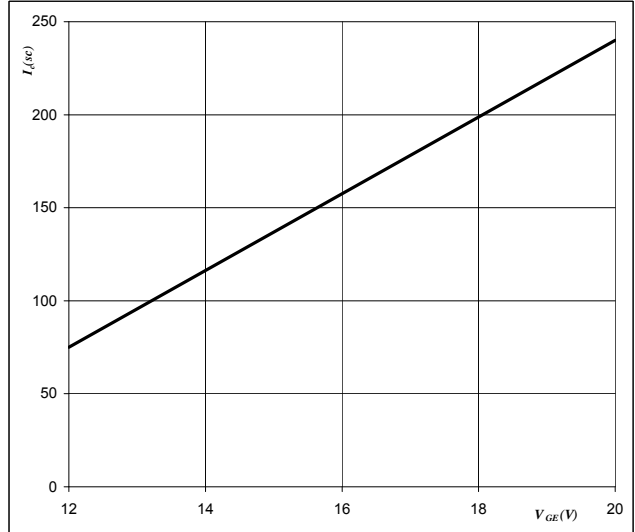

At  
 $V_{CE} \leq 600 \text{ V}$   
 $T_j = 175 \text{ } ^\circ\text{C}$

Figure 29 IGBT

Reverse bias safe operating area

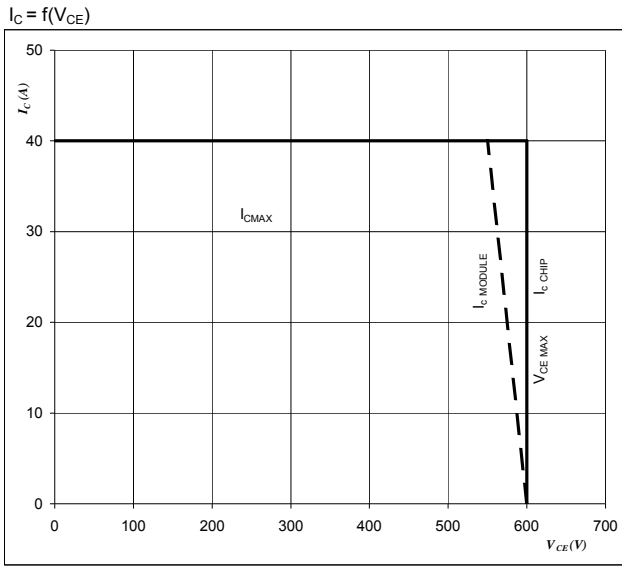

At

$T_J = T_{J,max} - 25 \text{ } ^\circ\text{C}$

$U_{ocmin} = U_{ccplus}$

Switching mode : 3 level switching

## Brake

Figure 1 Brake IGBT

Typical output characteristics

$$I_C = f(V_{CE})$$

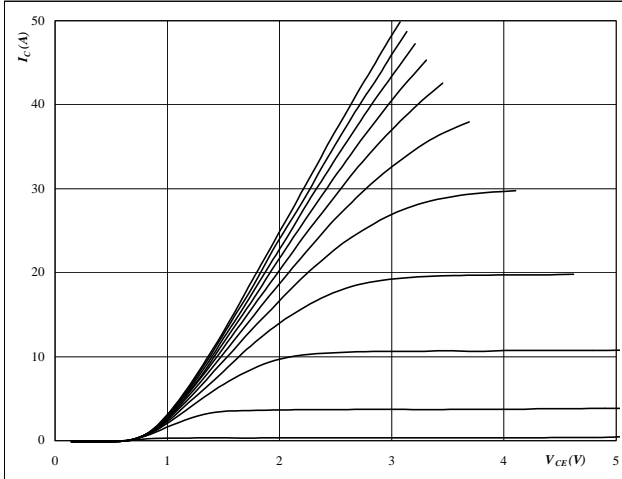

At  
 $t_p = 250 \mu s$   
 $T_j = 25 \text{ }^\circ C$   
 $V_{GE}$  from 7 V to 17 V in steps of 1 V

Figure 2 Brake IGBT

Typical output characteristics

$$I_C = f(V_{CE})$$

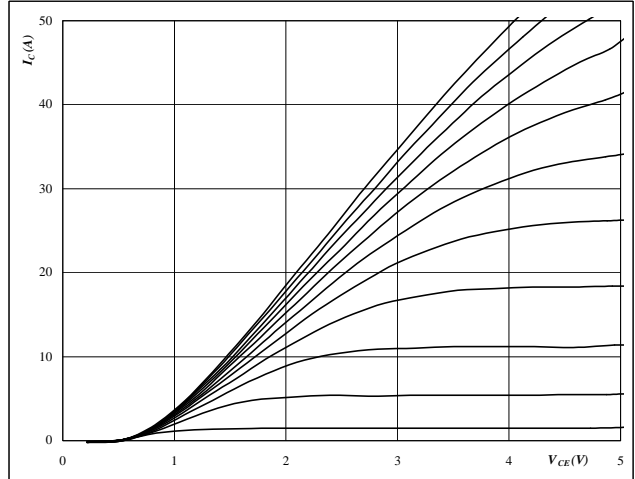

At  
 $t_p = 250 \mu s$   
 $T_j = 125 \text{ }^\circ C$   
 $V_{GE}$  from 7 V to 17 V in steps of 1 V

Figure 3 Brake IGBT

Typical transfer characteristics

$$I_C = f(V_{GE})$$

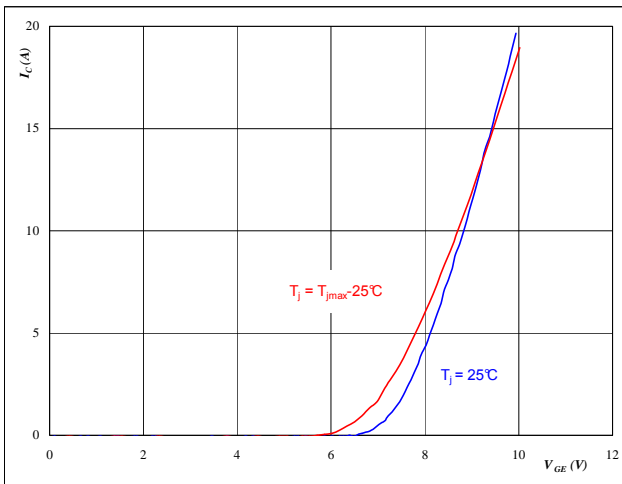

At  
 $t_p = 250 \mu s$   
 $V_{CE} = 10 \text{ V}$

Figure 4 Brake FWD

Typical diode forward current as a function of forward voltage

$$I_F = f(V_F)$$

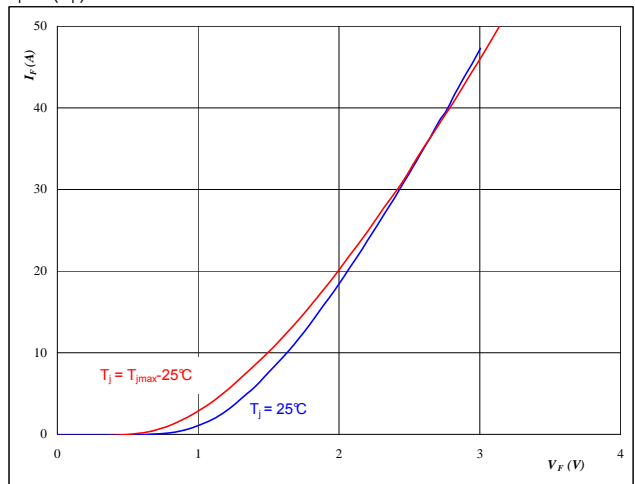

At  
 $t_p = 250 \mu s$

## Brake

**Figure 5** Brake IGBT

Typical switching energy losses  
as a function of collector current

$E = f(I_C)$

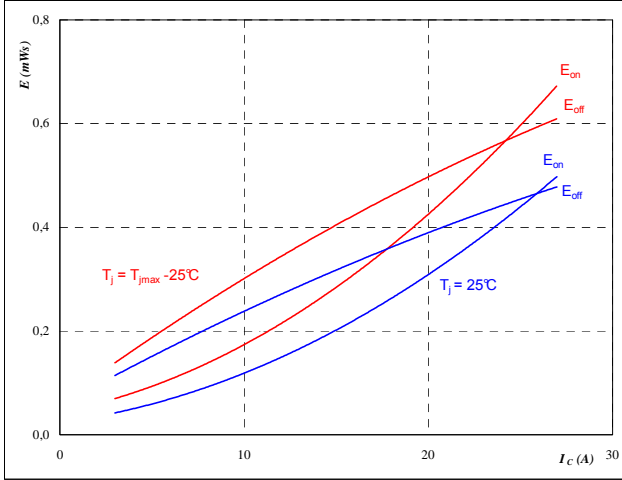

With an inductive load at

$T_j = 25/125$  °C  
 $V_{CE} = 300$  V  
 $V_{GE} = 15$  V  
 $R_{gon} = 16$  Ω  
 $R_{goff} = 8$  Ω

**Figure 6** Brake IGBT

Typical switching energy losses  
as a function of gate resistor

$E = f(R_G)$

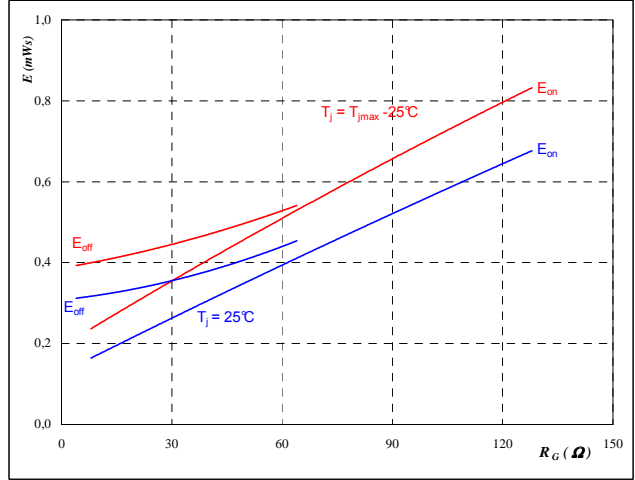

With an inductive load at

$T_j = 25/125$  °C  
 $V_{CE} = 300$  V  
 $V_{GE} = 15$  V  
 $I_C = 15$  A

**Figure 7** Brake FWD

Typical reverse recovery energy loss  
as a function of collector current

$E_{rec} = f(I_C)$

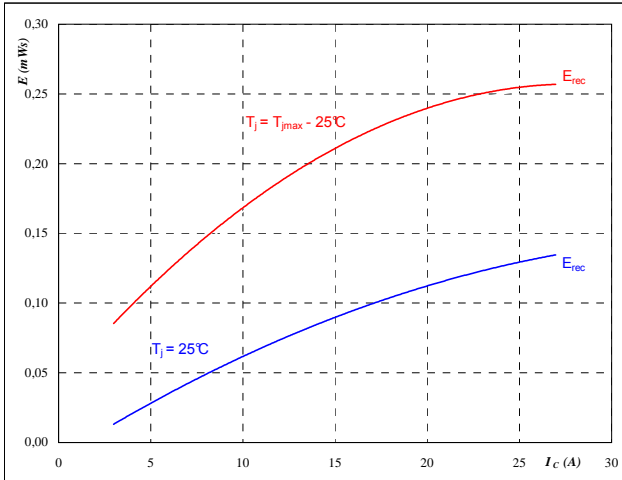

With an inductive load at

$T_j = 25/125$  °C  
 $V_{CE} = 300$  V  
 $V_{GE} = 15$  V  
 $R_{gon} = 16$  Ω

**Figure 8** Brake FWD

Typical reverse recovery energy loss  
as a function of gate resistor

$E_{rec} = f(R_G)$

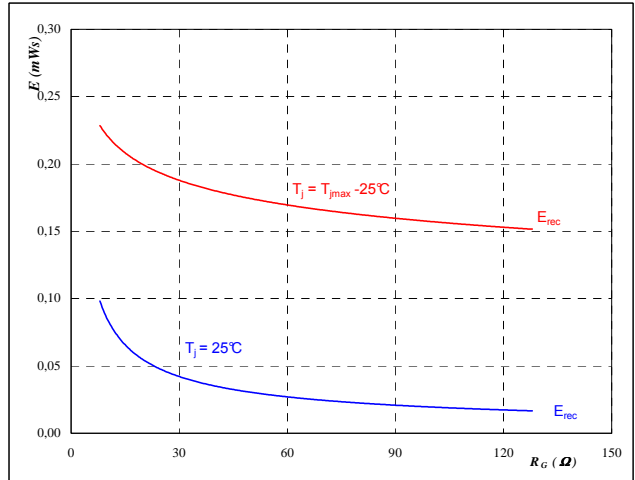

With an inductive load at

$T_j = 25/125$  °C  
 $V_{CE} = 300$  V  
 $V_{GE} = 15$  V  
 $I_C = 15$  A

## Brake

Figure 9 Brake IGBT

Typical switching times as a function of collector current  
 $t = f(I_C)$

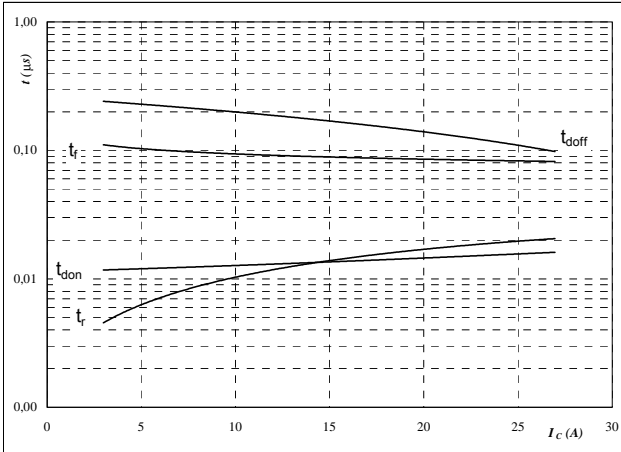

With an inductive load at  
 $T_j = 25/125$  °C  
 $V_{CE} = 300$  V  
 $V_{GE} = 15$  V  
 $R_{gon} = 16$  Ω  
 $R_{goff} = 8$  Ω

Figure 10 Brake IGBT

Typical switching times as a function of gate resistor  
 $t = f(R_G)$

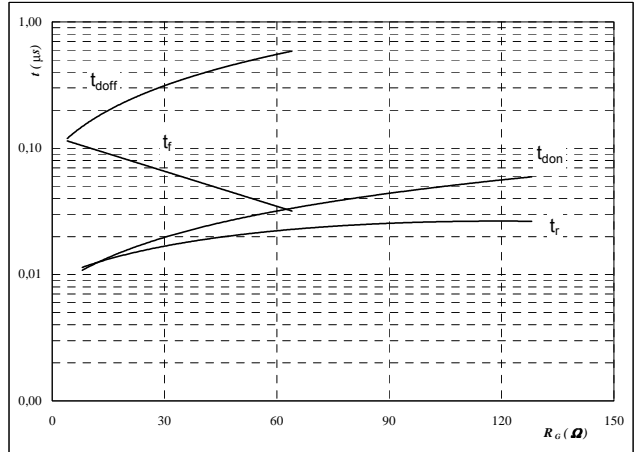

With an inductive load at  
 $T_j = 25/125$  °C  
 $V_{CE} = 300$  V  
 $V_{GE} = 15$  V  
 $I_C = 15$  A

Figure 11 Brake IGBT

IGBT transient thermal impedance as a function of pulse width  
 $Z_{thJH} = f(t_p)$

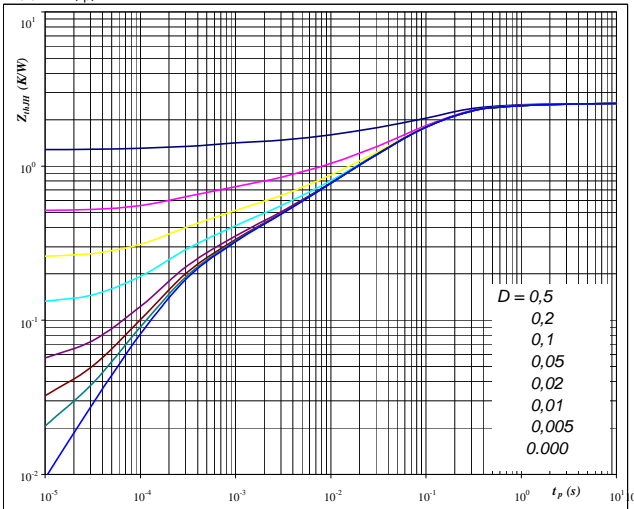

At Thermal grease  $R_{thJH} = 2,55$  K/W  
 D = Phase change interface  
 At Phase change interface  $R_{thJH} = 0,60$  K/W

Figure 12 Brake FWD

FWD transient thermal impedance as a function of pulse width  
 $Z_{thJH} = f(t_p)$

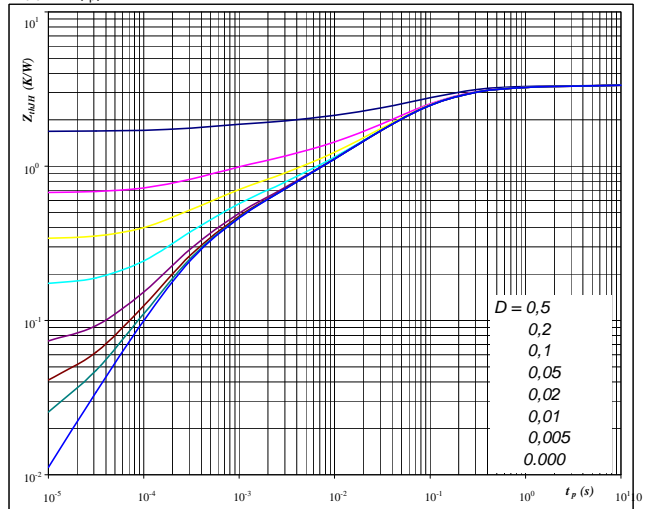

At Thermal grease  $R_{thJH} = 3,35$  K/W  
 D = Phase change interface  
 At Phase change interface  $R_{thJH} = 1,27$  K/W

## Brake

**Figure 13** Brake IGBT

**Power dissipation as a function of heatsink temperature**

$$P_{tot} = f(T_h)$$

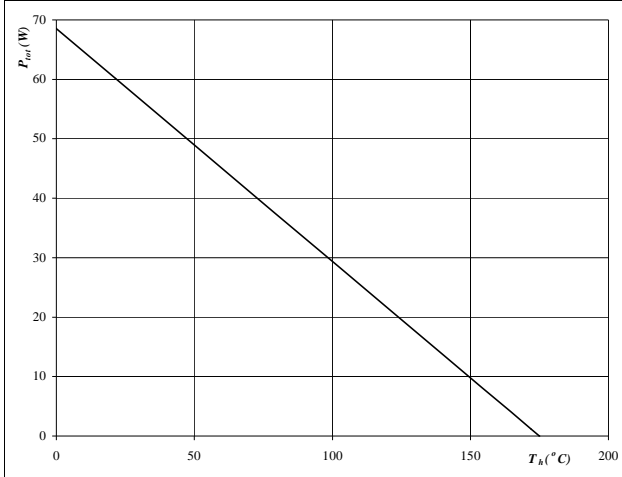

**At**  
 $T_j = 175$  °C

**Figure 14** Brake IGBT

**Collector current as a function of heatsink temperature**

$$I_C = f(T_h)$$

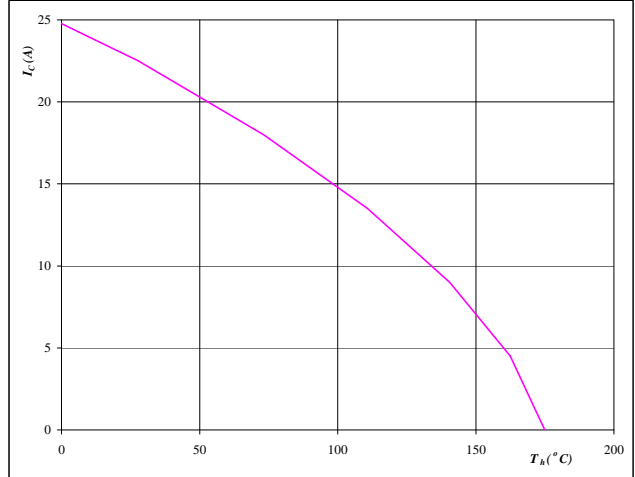

**At**  
 $T_j = 175$  °C  
 $V_{GE} = 15$  V

**Figure 15** Brake FWD

**Power dissipation as a function of heatsink temperature**

$$P_{tot} = f(T_h)$$

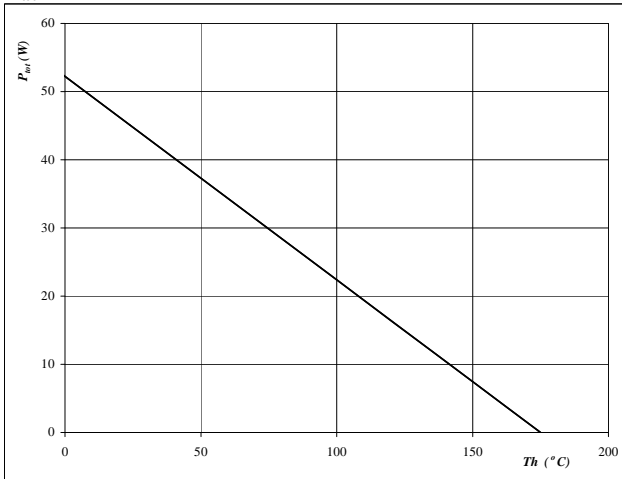

**At**  
 $T_j = 175$  °C

**Figure 16** Brake FWD

**Forward current as a function of heatsink temperature**

$$I_F = f(T_h)$$

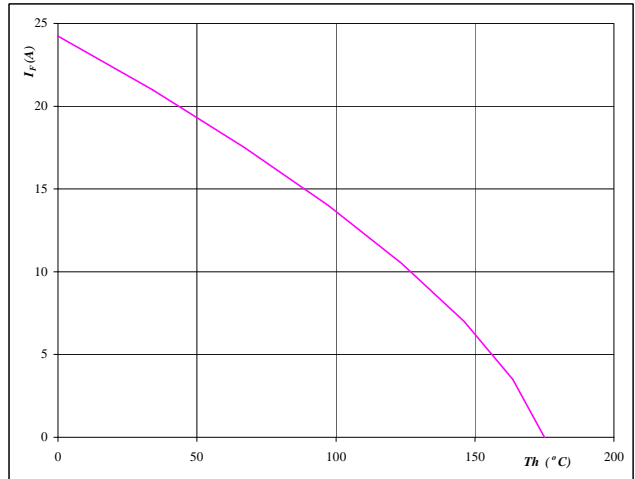

**At**  
 $T_j = 175$  °C



## Input Rectifier Bridge

**Figure 1** Rectifier diode

Typical diode forward current as a function of forward voltage

$I_F = f(V_F)$

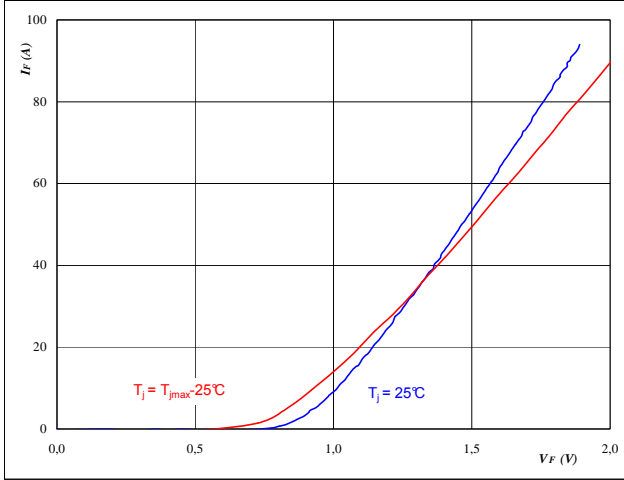

At  
 $t_p = 250 \mu s$

**Figure 2** Rectifier diode

Diode transient thermal impedance as a function of pulse width

$Z_{thJH} = f(t_p)$

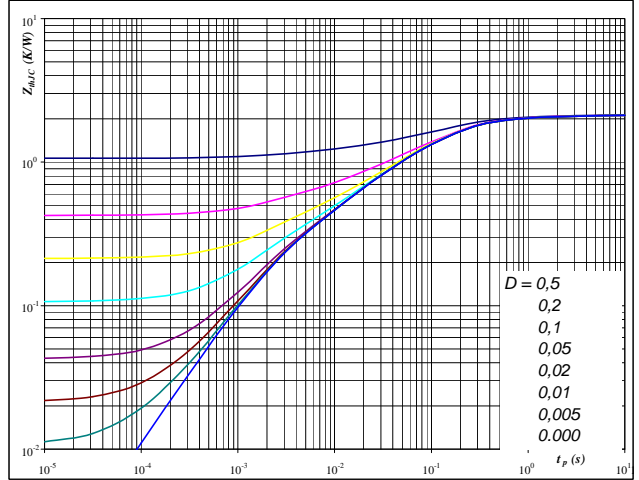

At  
 $D = t_p / T$   
 $R_{thJH} = 2,1 \text{ K/W}$

**Figure 3** Rectifier diode

Power dissipation as a function of heatsink temperature

$P_{tot} = f(T_h)$

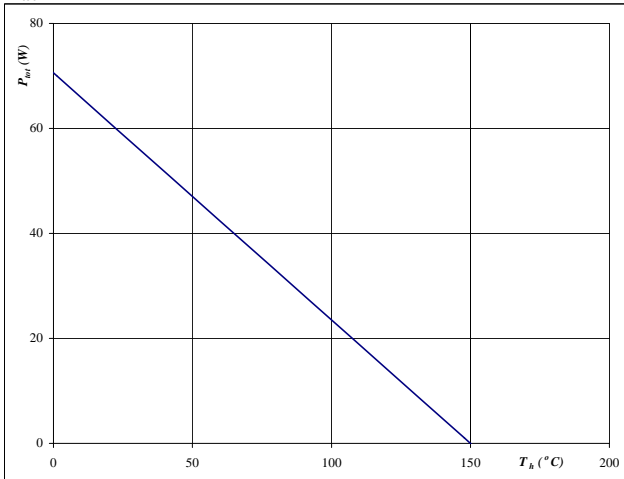

At  
 $T_j = 150 \text{ °C}$

**Figure 4** Rectifier diode

Forward current as a function of heatsink temperature

$I_F = f(T_h)$

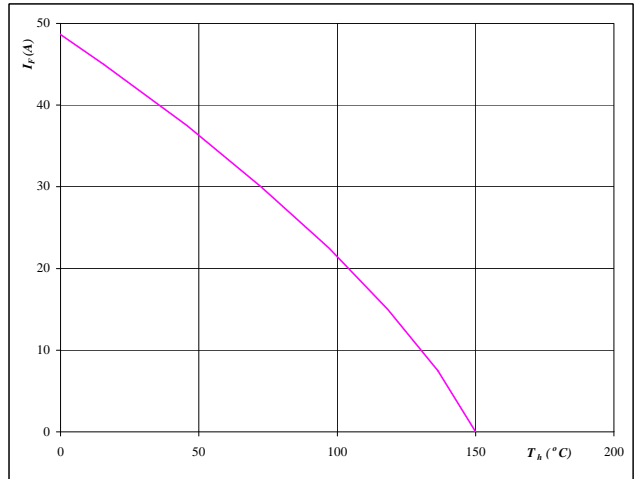

At  
 $T_j = 150 \text{ °C}$

## Thermistor

Figure 1 Thermistor

Typical NTC characteristic  
as a function of temperature

$R_T = f(T)$

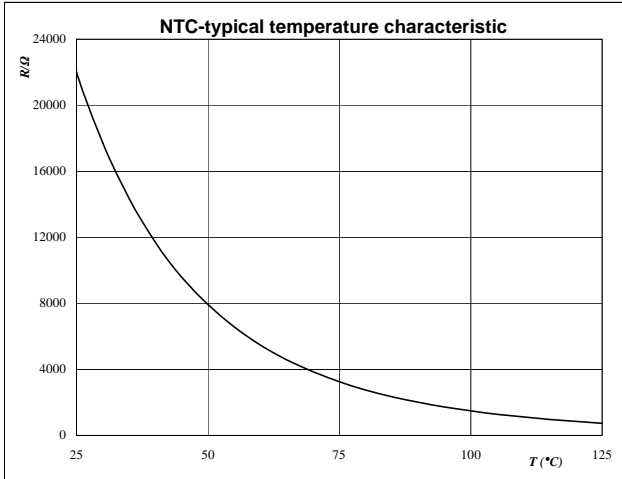

Figure 2 Thermistor

Typical NTC resistance values

$$R(T) = R_{25} \cdot e^{\left( B_{25/100} \left( \frac{1}{T} - \frac{1}{T_{25}} \right) \right)} \quad [\Omega]$$

T [°C]	R <sub>nom</sub> [Ω]	R <sub>min</sub> [Ω]	R <sub>max</sub> [Ω]	ΔR/R [±%]
-55	2089434,5	1506495,4	2672373,6	27,9
0	71804,2	59724,4	83884	16,8
10	43780,4	37094,4	50466,5	15,3
20	27484,6	23684,6	31284,7	13,8
25	22000	19109,3	24890,7	13,1
30	17723,3	15512,2	19934,4	12,5
60	5467,9	4980,6	5955,1	8,9
70	3848,6	3546	4151,1	7,9
80	2757,7	2568,2	2947,1	6,9
90	2008,9	1889,7	2128,2	5,9
<b>100</b>	<b>1486,1</b>	<b>1411,8</b>	<b>1560,4</b>	<b>5</b>
150	400,2	364,8	435,7	8,8

## Switching Definitions Output Inverter

General conditions	
$T_j$	= 125 °C
$R_{gon}$	= 16 Ω
$R_{goff}$	= 8 Ω

Figure 1 Output inverter IGBT

Turn-off Switching Waveforms & definition of  $t_{doff}$ ,  $t_{Eoff}$   
 ( $t_{Eoff}$  = integrating time for  $E_{off}$ )

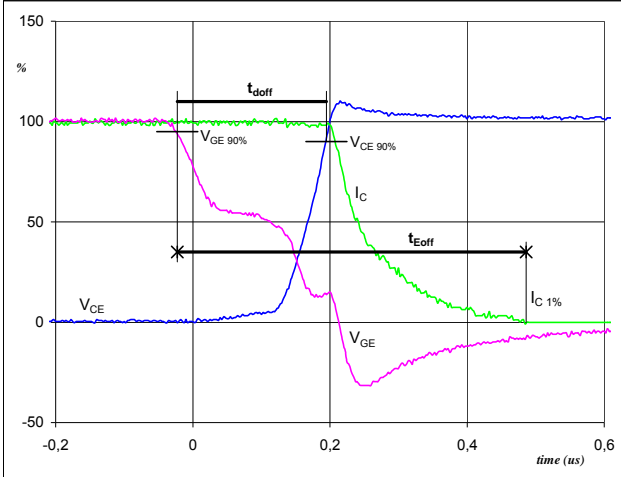

$V_{GE}(0\%) =$	0	V
$V_{GE}(100\%) =$	15	V
$V_C(100\%) =$	300	V
$I_C(100\%) =$	20	A
$t_{doff} =$	0,21	μs
$t_{Eoff} =$	0,51	μs

Figure 2 Output inverter IGBT

Turn-on Switching Waveforms & definition of  $t_{don}$ ,  $t_{Eon}$   
 ( $t_{Eon}$  = integrating time for  $E_{on}$ )

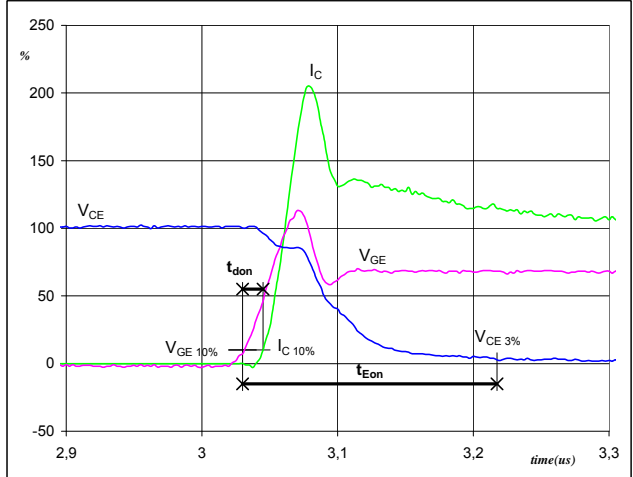

$V_{GE}(0\%) =$	0	V
$V_{GE}(100\%) =$	15	V
$V_C(100\%) =$	300	V
$I_C(100\%) =$	20	A
$t_{don} =$	0,01	μs
$t_{Eon} =$	0,19	μs

Figure 3 Output inverter IGBT

Turn-off Switching Waveforms & definition of  $t_f$

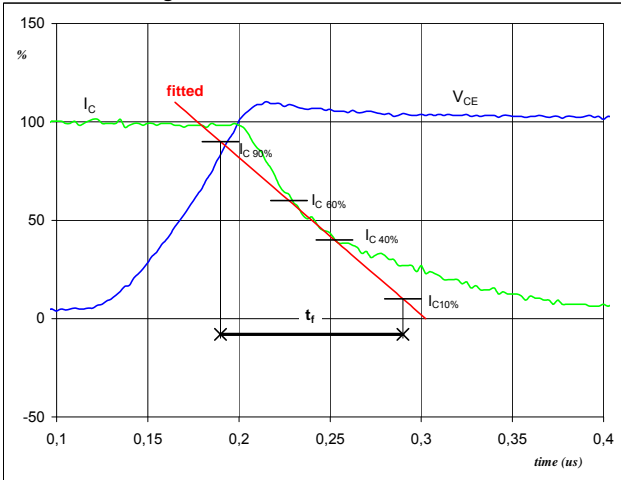

$V_C(100\%) =$	300	V
$I_C(100\%) =$	20	A
$t_f =$	0,10	μs

Figure 4 Output inverter IGBT

Turn-on Switching Waveforms & definition of  $t_r$

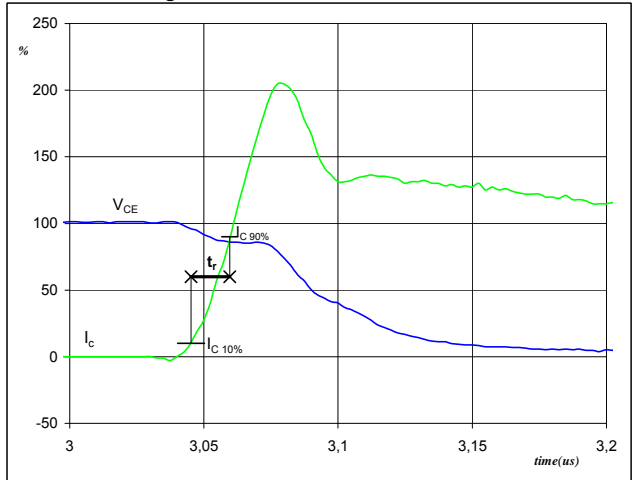

$V_C(100\%) =$	300	V
$I_C(100\%) =$	20	A
$t_r =$	0,02	μs

## Switching Definitions Output Inverter

Figure 5 Output inverter IGBT

Turn-off Switching Waveforms & definition of  $t_{Eoff}$

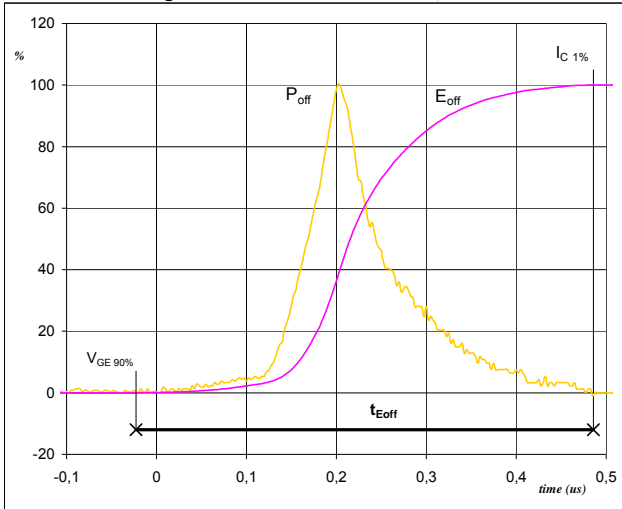

$P_{off} (100\%) = 5,99 \text{ kW}$   
 $E_{off} (100\%) = 0,65 \text{ mJ}$   
 $t_{Eoff} = 0,51 \text{ }\mu\text{s}$

Figure 6 Output inverter IGBT

Turn-on Switching Waveforms & definition of  $t_{Eon}$

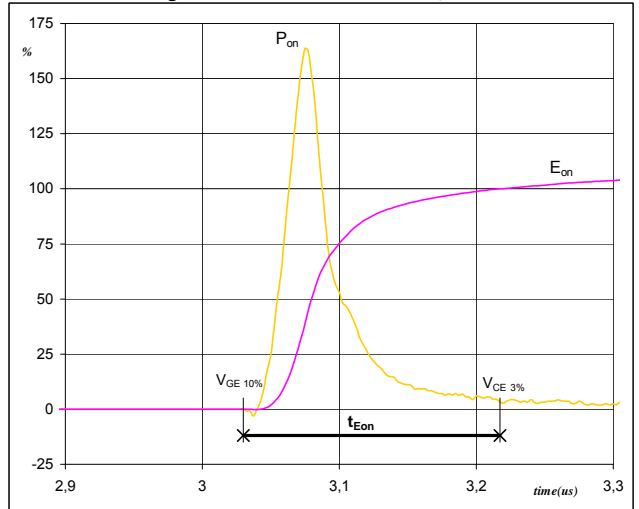

$P_{on} (100\%) = 5,99 \text{ kW}$   
 $E_{on} (100\%) = 0,43 \text{ mJ}$   
 $t_{Eon} = 0,19 \text{ }\mu\text{s}$

Figure 7 Output inverter FWD

Gate voltage vs Gate charge (measured)

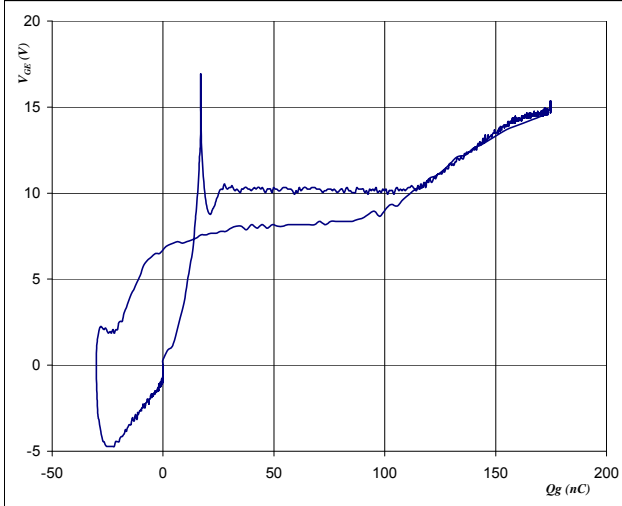

$V_{GEoff} = 0 \text{ V}$   
 $V_{GEon} = 15 \text{ V}$   
 $V_C (100\%) = 300 \text{ V}$   
 $I_C (100\%) = 20 \text{ A}$   
 $Q_g = 174,72 \text{ nC}$

Figure 8 Output inverter IGBT

Turn-off Switching Waveforms & definition of  $t_{rr}$

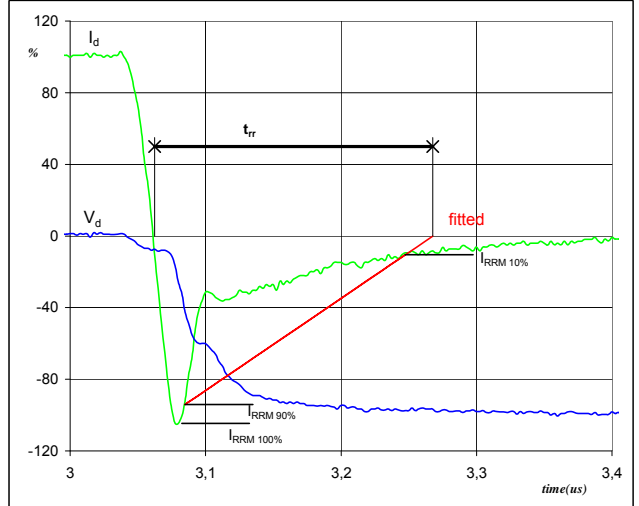

$V_d (100\%) = 300 \text{ V}$   
 $I_d (100\%) = 20 \text{ A}$   
 $I_{RRM} (100\%) = 21 \text{ A}$   
 $t_{rr} = 0,19 \text{ }\mu\text{s}$

## Switching Definitions Output Inverter

Figure 9 Output inverter FWD

Turn-on Switching Waveforms & definition of  $t_{Qrr}$   
 ( $t_{Qrr}$  = integrating time for  $Q_{rr}$ )

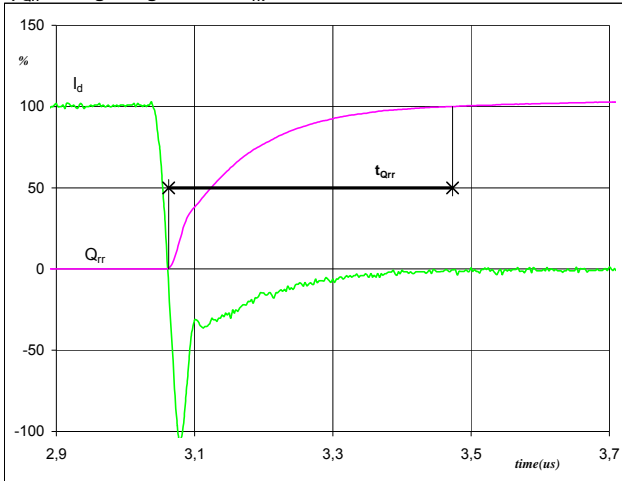

$I_d$ (100%) =	20	A
$Q_{rr}$ (100%) =	1,35	$\mu\text{C}$
$t_{Qrr}$ =	0,41	$\mu\text{s}$

Figure 10 Output inverter FWD

Turn-on Switching Waveforms & definition of  $t_{Erec}$   
 ( $t_{Erec}$  = integrating time for  $E_{rec}$ )

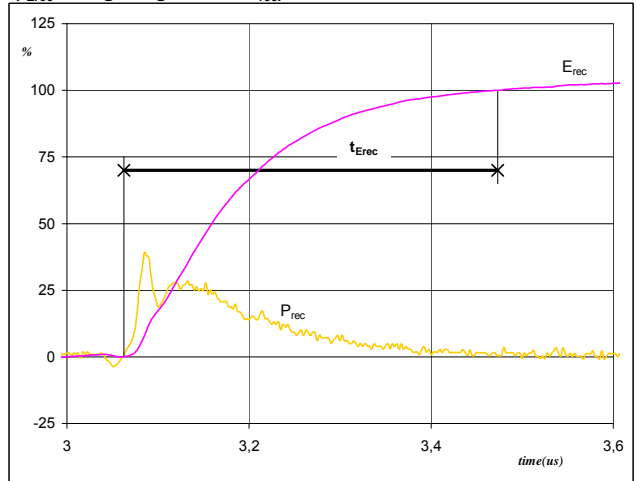

$P_{rec}$ (100%) =	5,99	kW
$E_{rec}$ (100%) =	0,27	mJ
$t_{Erec}$ =	0,41	$\mu\text{s}$

### Ordering Code and Marking - Outline - Pinout

#### Ordering Code & Marking

Version	Ordering Code	in DataMatrix as	in packaging barcode as
without thermal paste 12mm 2 clips housing	V23990-P545-A28-PM	P545-A28	P545-A28
without thermal paste 17mm 2 clips housing	V23990-P545-A29-PM	P545-A29	P545-A29
without thermal paste 12mm 2 clips housing	V23990-P545-C28-PM	P545-C28	P545-C28
without thermal paste 17mm 2 clips housing	V23990-P545-C29-PM	P545-C29	P545-C29

7	10.8	0
8	8.1	0
9	5.4	0
10	2.7	0
11	0	0
12	0	19.8
13	0	22.5
14	7.5	19.8
15	7.5	22.5
16	15	19.8
17	15	22.5
18	22.8	22.5
19	25.5	22.5
20	33.5	22.5
21	33.5	15
22	33.5	7.5
23	33.5	0

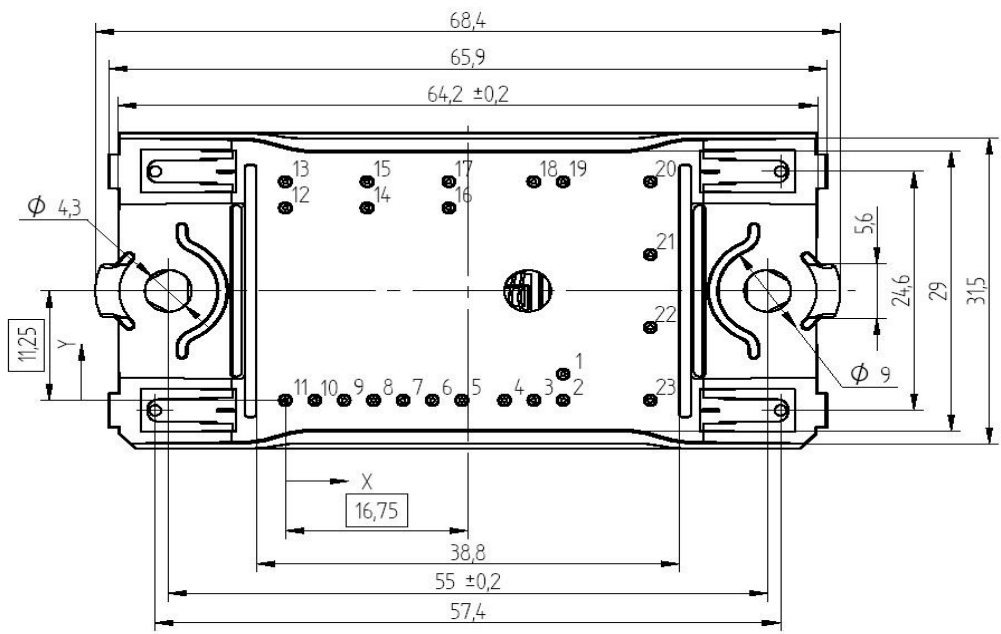

#### Pinout

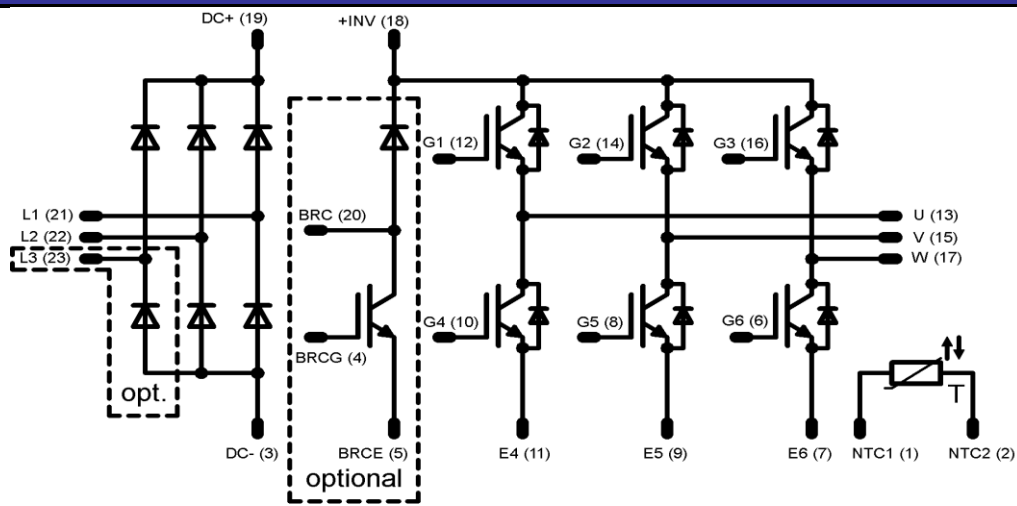

**DISCLAIMER**

The information given in this datasheet describes the type of component and does not represent assured characteristics. For tested values please contact Vincotech. Vincotech reserves the right to make changes without further notice to any products herein to improve reliability, function or design. Vincotech does not assume any liability arising out of the application or use of any product or circuit described herein; neither does it convey any license under its patent rights, nor the rights of others.

**LIFE SUPPORT POLICY**

Vincotech products are not authorised for use as critical components in life support devices or systems without the express written approval of Vincotech.

As used herein:

1. Life support devices or systems are devices or systems which, (a) are intended for surgical implant into the body, or (b) support or sustain life, or (c) whose failure to perform when properly used in accordance with instructions for use provided in labelling can be reasonably expected to result in significant injury to the user.
2. A critical component is any component of a life support device or system whose failure to perform can be reasonably expected to cause the failure of the life support device or system, or to affect its safety or effectiveness.